

Clamps 夹具

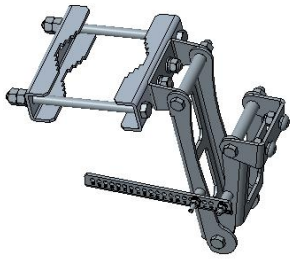

Upper bracket
上支架组件

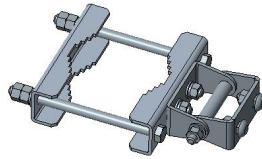

Lower bracket
下支架组件

Installation Tools 安装工具



18 mm combination wrench(2PCS)
16 mm combination wrench(2PCS)
8 mm combination wrench(2PCS)
两用扳手

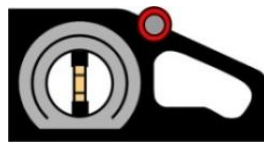

Inclinometer 倾角仪

Step 1: Assemble the joint part
第一步：组装连接件



Joint part 连接件

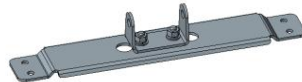

Step 2: Assemble the bracket
第二步：组装支架

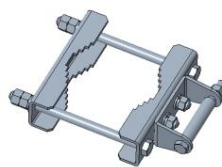
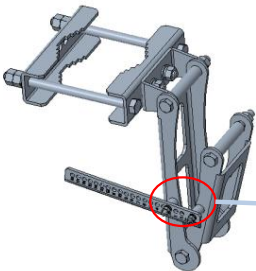

Step 3: Install the bracket
第三步：安装支架

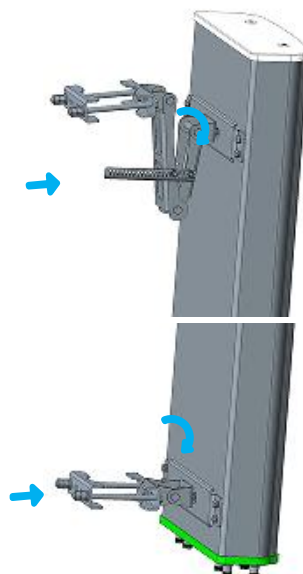
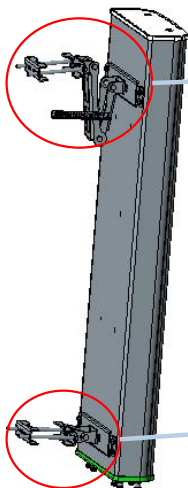

Follow the directions shown in the picture to install brackets.
请按图中所示将上支架、下支架安装到天线。

附件清单(Attachment list)

名称name	编号code	数量Quantity
长角臂 Length holder	17S108A01	1
短角臂 Short holder	17S108A02	1
角臂座 holder	12S20905	4
连接件 Joint part	12S20903	2
连接件 Joint part	17S204001	2
支撑管 Support pipe	17S108A05	4
长支撑柱 Length pillar	17S132A01	1
短支撑柱 Short pillar	17S132A02	1
角度板 Angle plate	17S108A06	1
螺栓 Bolt GB/T5783 M12×180		4
螺栓 Bolt GB/T5783 M10×110		4
螺栓 Bolt GB/T12 M10X25		4
螺栓 Bolt GB/T5783 M10×25		4
螺栓 Bolt GB/T5783 M5×35		2
螺母 Nut GB/T6170 M12		8
螺母 Nut GB/T6170 M10		12
螺母 Nut GB/T6170 M5		2
平垫圈 Flat washer GB/T97.1 12		4
弹簧垫圈 Spring washer GB/T93 12		4
平垫圈 Flat washer GB/T97.1 10		12
弹簧垫圈 Spring washer GB/T93 10		12
平垫圈 Flat washer GB/T97.1 5		2
弹簧垫圈 Spring washer GB/T93 5		2

Appearance of the actual antenna may differ from the pictures. —— 请以实物为准。

Follow the directions shown in the picture to install brackets.
请按图中所示安装好上支架、下支架。

Step 3: Install the antenna

第三步：安装天线

Pole diameter
抱杆直径
Φ 50~Φ114

Tighten all the nuts before lifting the antenna onto the tower. Ensure the bracket is fully folded.

上塔前确保此支架在0° 完全折起并锁紧所有螺母。

Install the Antenna on the pole as shown in the figure. The same installation method applies to both upper and lower brackets.

按图所示安装天线在抱杆上，上支架和下支架安装方式相同。

Check and tighten all the nuts when the installation is complete. The operating torques are given in the following figures.

安装完后，要检查并拧紧所有螺母。

The recommended

螺栓参考力矩：

M5=4 N·m； M10=35 N·m； M12=62 N·m

L

Step 4: Adjust the mechanical downtilt angle

第四步：调节天线的机械下倾角



Method 1
方法1

Precise reference
参考测量
Scale of bracket
(the actual scale
prevails)
支架刻度尺（实际
刻度请以实物为准）



Method 2
方法2

Precise measurement
精确测量

Before adjustment, adjust the inclinometer to the desired downtilt angle. After adjustment, locate the bead in the middle of the inclinometer.
调节前，将倾角仪调到所需的下倾角度。调节后，倾角仪的水珠水平居中。

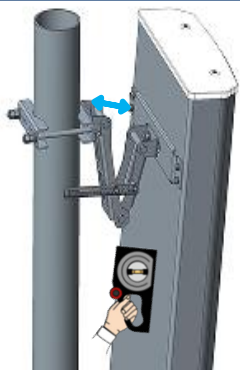

17S204

Mounting plate
distance
安装板距离
L(mm)

Down tilt angle
下倾角调节范围

1200±5

0-18°

After the adjustment is complete, tighten all the nuts.
角度调整完成后，拧紧所有螺母。
Only qualified personnel are allowed to install the antenna.
天线的安装需由合格的安装人员操作。